

# Low voltage Compandor

# NE/SA575

## DESCRIPTION

The NE/SA575 is a precision dual gain control circuit designed for low voltage applications. The NE/SA575's channel 1 is an expander, while channel 2 can be configured either for expander, compressor, or automatic level controller (ALC) application.

## FEATURES

- Operating voltage range from 3V to 7V
- Reference voltage of  $100mV_{RMS} = 0dB$
- One dedicated summing op amp per channel and two extra uncommitted op amps
- $600\Omega$  drive capability
- Single or split supply operation
- Wide input/output swing capability
- 3000V ESD protection

## APPLICATIONS

- Portable communications
- Cellular radio
- Cordless telephone
- Consumer audio

## PIN CONFIGURATION

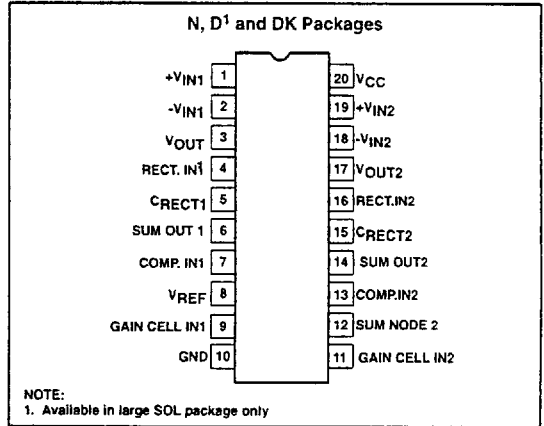

- Portable broadcast mixers
- Wireless microphones
- Modems
- Electric organs
- Hearing aids

## ORDERING INFORMATION

DESCRIPTION	TEMPERATURE RANGE	ORDER CODE	DWG
20-Pin Plastic Dual In-Line Package (DIP)	0 to +70°C	NE575N	0408
20-Pin Plastic Small Outline Large	0 to +70°C	NE575D	0172
20-Pin Plastic Shrink Small Outline Package (SSOP)	0 to +70°C	NE575DK	1563
20-Pin Plastic Dual In-Line Package (DIP)	-40 to +85°C	SA575N	0408
20-Pin Plastic Small Outline Large	-40 to +85°C	SA575D	0172
20-Pin Plastic Shrink Small Outline Package (SSOP)	-40 to +85°C	SA575DK	1563

## ABSOLUTE MAXIMUM RATINGS

SYMBOL	PARAMETER	RATING		UNITS
		NE575	SA575	
$V_{CC}$	Single supply voltage	-0.3 to 8	-0.3 to 8	V
$V_{IN}$	Voltage applied to any other pin	-0.3 to ( $V_{CC}+0.3$ )	-0.3 to ( $V_{CC}+0.3$ )	V
$T_A$	Operating ambient temperature range	-40 to +85	-40 to +85	°C
$T_{STG}$	Storage temperature range	-65 to +150	-65 to +150	°C
$\theta_{JA}$	Thermal impedance	DIP	68	°C/W
		SOL	112	°C/W
		SSOP	117	°C/W

7110826 0083064 907

Low voltage Comparator

NE/SA575

BLOCK DIAGRAM and TEST CIRCUIT

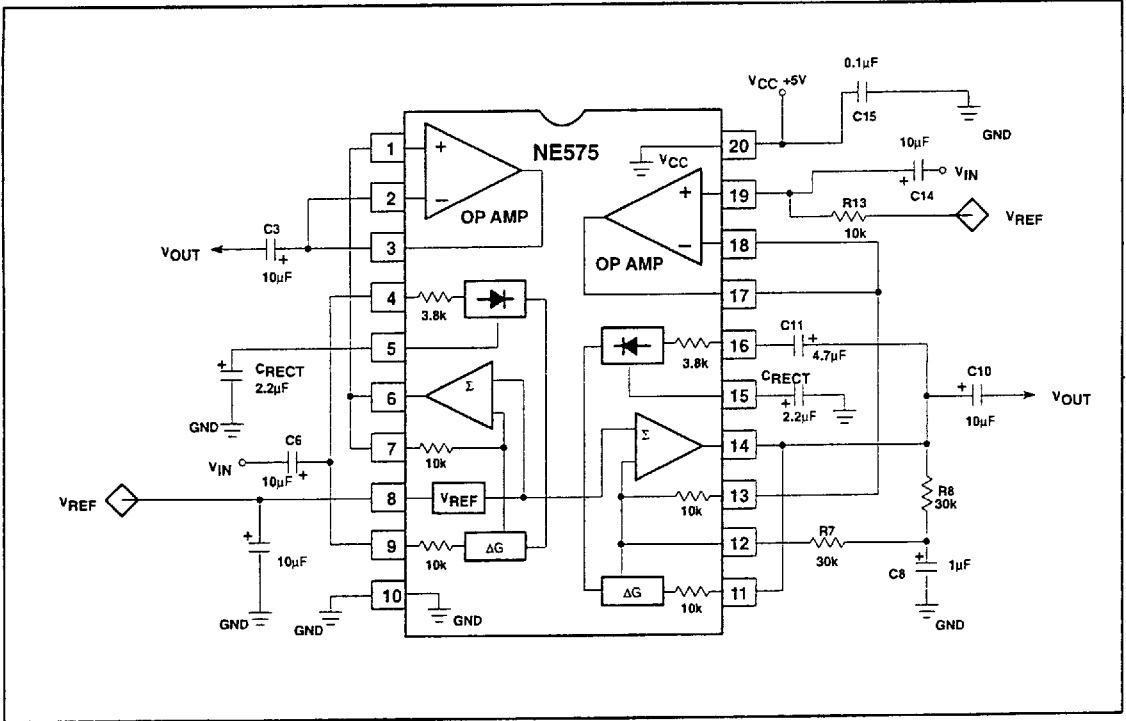

DC ELECTRICAL CHARACTERISTICS

Typical values are at  $T_A = 25^\circ\text{C}$ . Minimum and Maximum values are for the full operating temperature range: 0 to  $70^\circ\text{C}$  for NE575,  $-40$  to  $+85^\circ\text{C}$  for SA575, except SSOP package is tested at  $+25^\circ\text{C}$  only.  $V_{CC} = 5\text{V}$ , unless otherwise stated. Both channels are tested in the Expander mode (see Test Circuit)

SYMBOL	PARAMETER	TEST CONDITIONS	LIMITS						UNITS
			NE575			SA575			
			MIN	TYP	MAX	MIN	TYP	MAX	
For comparator, including summing amplifier									
$V_{CC}$	Supply voltage <sup>1</sup>		3	5	7	3	5	7	V
$I_{CC}$	Supply current	No signal	3	4.2	5.5	3	4.2	5.5	mA
$V_{REF}$	Reference voltage <sup>2</sup>	$V_{CC} = 5\text{V}$	2.4	2.5	2.6	2.4	2.5	2.6	V
$R_L$	Summing amp output load		10			10			kΩ
THD	Total harmonic distortion	1kHz, 0dB BW = 3.5kHz		0.12	1.0		0.12	1.5	%
$E_{NO}$	Output voltage noise	BW = 20kHz, $R_S = 0\Omega$		6	20		6	30	µV
0dB	Unity gain level	1kHz	-1.0		1.0	-1.5		1.5	dB
$V_{OS}$	Output voltage offset	No signal	-100		100	-150		150	mV
	Output DC shift	No signal to 0dB	-50		50	-100		100	mV
	Tracking error relative to 0dB	Gain cell input = 0dB, 1kHz Rectifier input = 6dB, 1kHz	-0.5		0.5	-1.0		1.0	dB
		Gain cell input = 0dB, 1kHz Rectifier input = -30dB, 1kHz	-0.5		0.5	-1.0		1.0	dB

## Low voltage Compressor

NE/SA575

## DC ELECTRICAL CHARACTERISTICS (cont.)

SYMBOL	PARAMETER	TEST CONDITIONS	LIMITS						UNITS
			NE575			SA575			
			MIN	TYP	MAX	MIN	TYP	MAX	
	Crosstalk	1kHz, 0dB, $C_{REF} = 220\mu F$		-80	-65		-80	-65	dB
<b>For operational amplifier</b>									
$V_O$	Output swing	$R_L = 10k\Omega$	$V_{CC}-0.4$	$V_{CC}$		$V_{CC}-0.4$	$V_{CC}$		V
$R_L$	Output load	1kHz	600			600			$\Omega$
CMR	input common-mode range		0		$V_{CC}$	0		$V_{CC}$	V
CMRR	Common-mode rejection ratio		60	80		60	80		dB
$I_B$	Input bias current	$V_{IN} = 0.5V$ to 4.5V	-0.5		0.5	-1		1	$\mu A$
$V_{OS}$	Input offset voltage			3			3		mV
$A_{VOL}$	Open-loop gain	$R_L = 10k\Omega$		80			80		dB
SR	Slew rate	Unity gain		1			1		V/ $\mu s$
GBW	Bandwidth	Unity gain		3			3		MHz
$E_{NI}$	Input voltage noise	BW = 20kHz		2.5			2.5		$\mu V$
PSRR	Power supply rejection ratio	1kHz, 250mV		60			60		dB

## NOTES:

- 1 Operation down to  $V_{CC} = 2V$  is possible, but performance is reduced. See curves in Figure 5a and 5b
2. Reference voltage,  $V_{REF}$  is typically at  $1/2V_{CC}$ .

## FUNCTIONAL DESCRIPTION

This section describes the basic subsystems and applications of the NE/SA575 Compressor. More theory of operation on compressors can be found in AN174 and AN176. The typical applications of the NE/SA575 low voltage compressor in an Expander (1:2), Compressor (2:1) and Automatic Level Control (ALC) function are explained. These three circuit configurations are shown in Figures 1, 2, 3 respectively.

The NE/SA575 has two channels for a complete compressing system. The left channel, A, can be configured as a 1:2 Expander while the right channel, B, can be configured as either a 2:1 Compressor, a 1:2 Expander or an ALC. Each channel consists of the basic compressing building blocks of rectifier cell, variable gain cell, summing amplifier and  $V_{REF}$  cell. In addition, the NE/SA575 has two additional high performance uncommitted op amps which can be utilized for application such as filtering, pre-emphasis/de-emphasis or buffering.

Figure 4 shows the complete schematic for the applications demo board. Channel A is configured as an expander while channel B is configured so that it can be used either as a compressor or as an ALC circuit. The switch, S1, toggles the circuit between compressor and ALC mode. Jumpers J1 and J2 can be used to either include the additional op amps for signal conditioning or exclude them from the signal path. Bread boarding space is provided for R1, R2, C1, C2, R10, R11, C10 and C11 so that the response can be tailored for each individual need. The components as specified are suitable for the complete audio spectrum from 20Hz to 20kHz.

The most common configuration is as a unity gain non-inverting buffer where R1, C1, C2, R10, C10 and C11 are eliminated and R2 and R11 are shorted. Capacitors C3, C5, C8, and C12 are for DC blocking. In systems where the inputs and outputs are AC coupled, these capacitors and resistors can be eliminated. Capacitors C4 and C9 are for setting the attack and release time constant.

C6 is for decoupling and stabilizing the voltage reference circuit. The value of C6 should be such that it will offer a very low impedance to the lowest frequencies of interest. Too small a capacitor will allow supply ripple to modulate the audio path. The

better filtered the power supply, the smaller this capacitor can be. R12 provides DC reference voltage to the amplifier of channel B. R6 and R7 provide a DC feedback path for the summing amp of channel B, while C7 is a short-circuit to ground for signals. C14 and C15 are for power supply decoupling. C14 can also be eliminated if the power supply is well regulated with very low noise and ripple.

## DEMONSTRATED PERFORMANCE

The applications demo board was built and tested for a frequency range of 20Hz to 20kHz with the component values as shown in Figure 4 and  $V_{CC} = 5V$ . In the expander mode, the typical input dynamic range was from -34dB to +12dB where 0dB is equal to 100mV<sub>RMS</sub>. The typical unity gain level measured at 0dB @ 1kHz input was  $\pm 0.5dB$  and the typical tracking error was  $\pm 0.1dB$  for input range of -30 to +10dB.

In the compressor mode, the typical input dynamic range was from -42dB to  $\pm 18dB$  with a tracking error  $\pm 0.1dB$  and the typical unity gain level was  $\pm 0.5dB$ .

In the ALC mode, the typical input dynamic range was from -42dB to +8dB with typical output deviation of  $\pm 0.2dB$  about the nominal output of 0dB. For input greater than +9dB in ALC configuration, the summing amplifier sometimes exhibits high frequency oscillations. There are several solutions to this problem. The first is to lower the values of R6 and R7 to 20k $\Omega$  each. The second is to add a current limiting resistor in series with C12 at Pin 13. The third is to add a compensating capacitor of about 22 to 30pF between the input and output of summing amplifier (Pins 12 and 14). With any one of the above recommendations, the typical ALC mode input range increased to +18dB yielding a dynamic range of over 60dB.

## EXPANDOR

The typical expander configuration is shown in Figure 1. The variable gain cell and the rectifier cell are in the signal input path. The  $V_{REF}$  is always  $1/2 V_{CC}$  to provide the maximum headroom without clipping. The 0dB ref is 100mV<sub>RMS</sub>. The input is AC coupled through C5, and the output is AC coupled through C3. If in a system the inputs and outputs are AC coupled, then C3 and C5 can be eliminated, thus requiring only one external component, C4. The variable gain cell and rectifier cell are DC coupled so any offset

# Low voltage Compressor

NE/SA575

voltage between Pins 4 and 9 will cause small offset error current in the rectifier cell. This will affect the accuracy of the gain cell. This can be improved by using an extra capacitor from the input to Pin 4 and eliminating the DC connection between Pins 4 and 9. The expander gain expression and the attack and release time constant is given by Equation 1 and Equation 2, respectively.

Equation 1

$$\text{Expander gain} = \frac{4V_{IN(avg)}}{3.8k \times 100\mu A}$$

where  $V_{IN(avg)} = 0.95V_{IN(RMS)}$

Equation 2.

$$\tau_R = \tau_A = 10k \times C_{RECT} = 10k \times C4$$

## COMPRESSOR

The typical compressor configuration is shown in Figure 2. In this mode, the rectifier cell and variable gain cell are in the feedback path. R6 and R7 provide the DC feedback to the summing amplifier. The input is AC coupled through C12 and output is AC coupled through C8. In a system with inputs and outputs AC coupled, C8 and C12 could be eliminated and only R6, R7, C7, and C13 would be required. If the external components R6, R7 and C7 are eliminated, then the output of the summing amplifier will motor-boat in absence of signals or at extremely low signals. This is because there is no DC feedback path from the output to input. In the presence of an AC signal this phenomenon is not observed and the circuit will appear to function properly.

The compressor gain expression and the attack and release time constant is given by Equation 3 and Equation 4, respectively

Equation 3

$$\text{Compressor gain} = \left[ \frac{3.8k \times 100\mu A}{4V_{IN(avg)}} \right]^{1/2}$$

where  $V_{IN(avg)} = 0.95V_{IN(RMS)}$

Equation 4.

$$\tau_R = \tau_A = 10k \times C_{RECT} = 10k \times C4$$

## AUTOMATIC LEVEL CONTROL

The typical Automatic Level Control circuit configuration is shown in Figure 3. It can be seen that it is quite similar to the compressor schematic except that the input to the rectifier cell is from the input path and not from the feedback path. The input is AC coupled through C12 and C13 and the output is AC coupled through C8. Once again, as in the previous cases, if the system input and output signals are already AC coupled, then C12, C13 and C8 could be eliminated. Concerning the compressor, removing R6, R7 and C7 will cause motor-boating in absence of signals. C<sub>COMP</sub> is necessary to stabilize the summing amplifier at higher input levels. This circuit provides an input dynamic range greater than 60dB with the output within ±0.5dB typical. The necessary design expressions are given by Equation 5 and Equation 6, respectively.

Equation 5.

$$\text{ALC gain} = \frac{3.8k \times 100\mu A}{4V_{IN(avg)}}$$

Equation 6.

$$\tau_R = \tau_A = 10k \times C_{RECT} = 10k \times C9$$

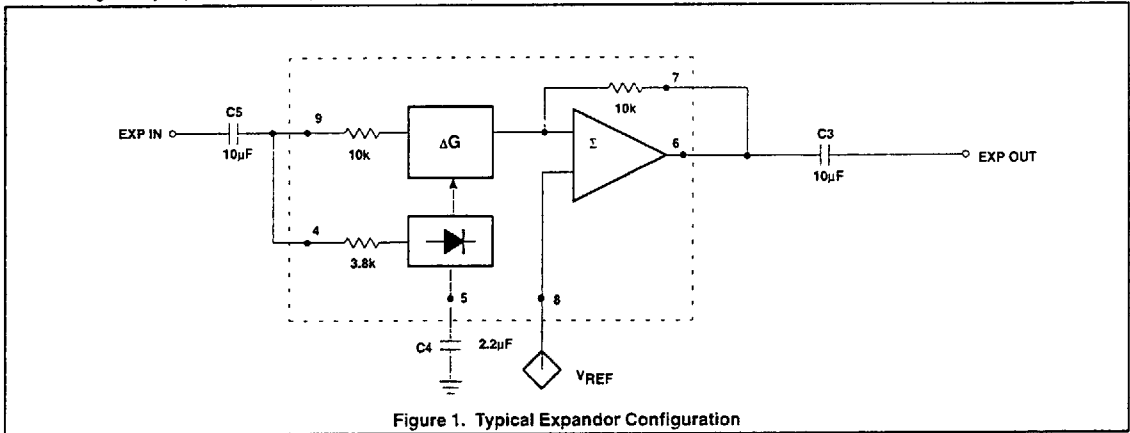

Figure 1. Typical Expander Configuration

Low voltage Comparator

NE/SA575

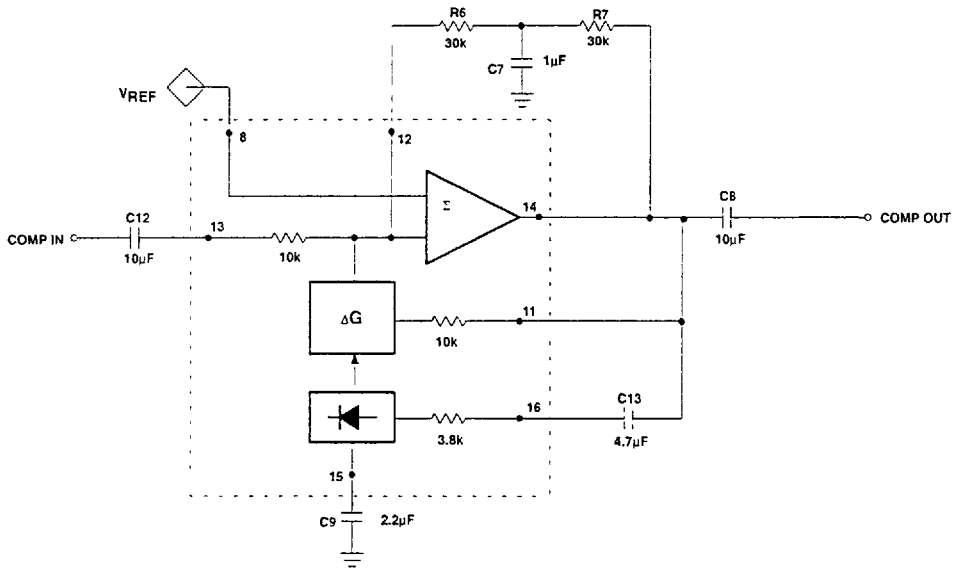

Figure 2. Typical Compressor Configuration

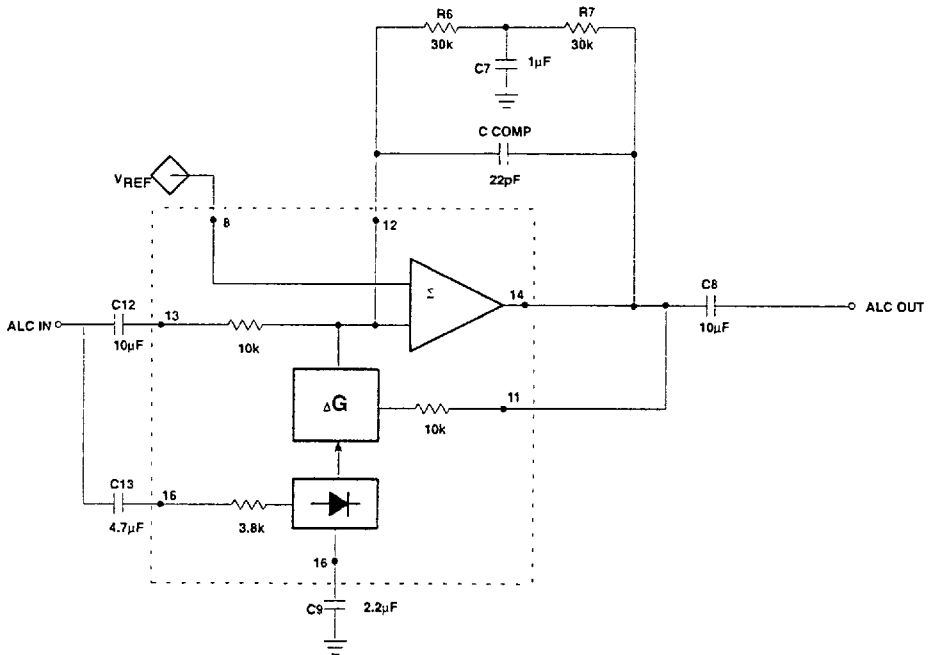

Figure 3. Typical ALC Configuration

Low voltage Comparator

NE/SA575

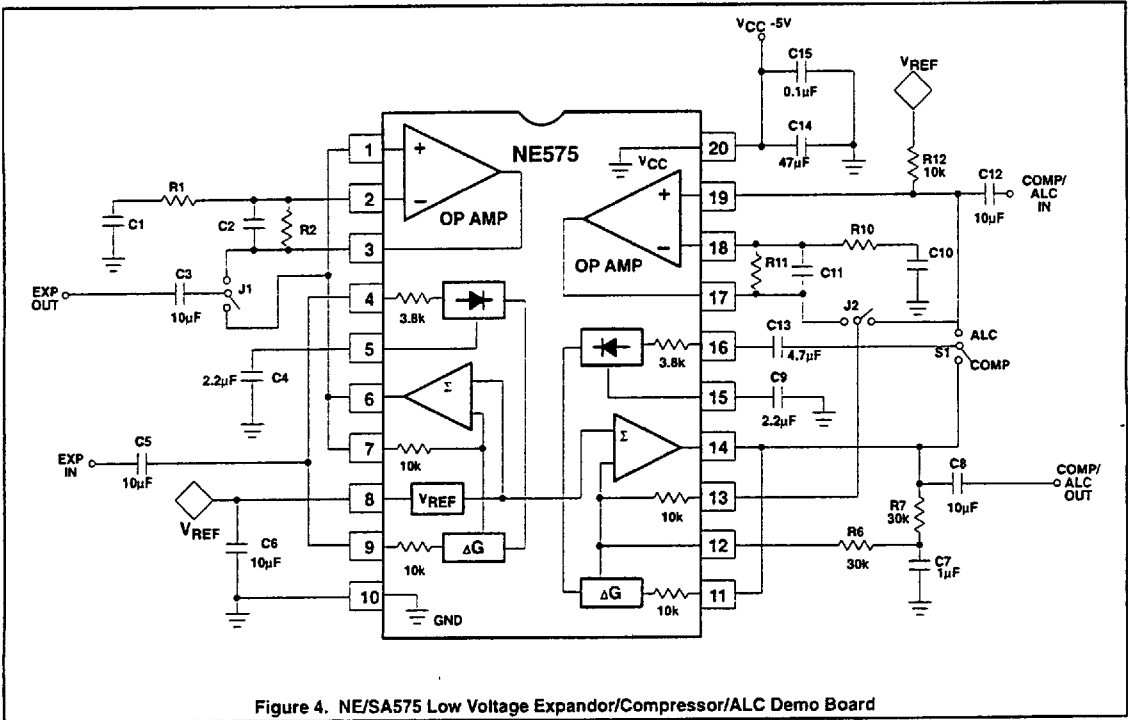
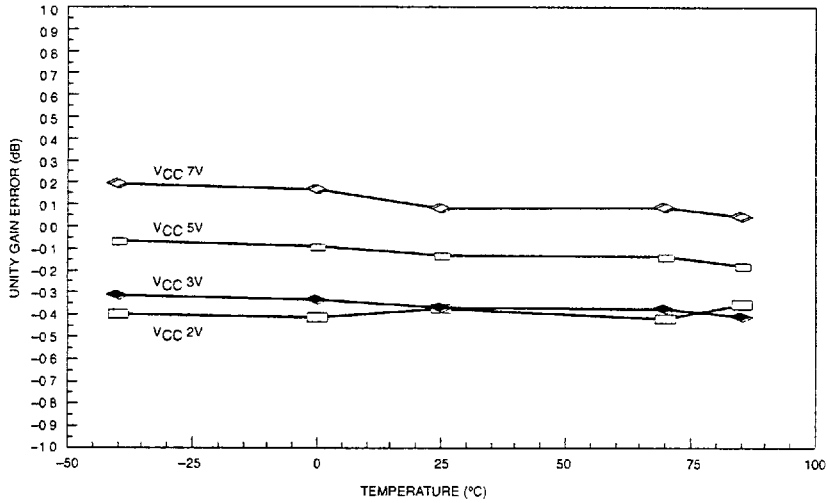

Figure 4. NE/SA575 Low Voltage Expander/Compressor/ALC Demo Board

Low voltage Comparator

NE/SA575



a. Unity Gain Error vs Temperature and V<sub>CC</sub>

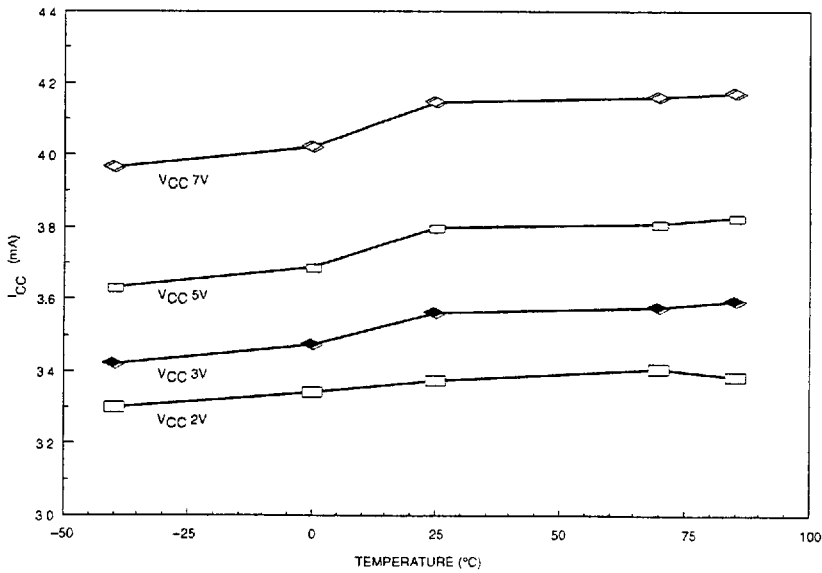

b. I<sub>CC</sub> vs Temperature and V<sub>CC</sub>

Figure 5. Temperature and V<sub>CC</sub> Curves

# Low voltage Compador

# NE/SA575

## TYPICAL PERFORMANCE CHARACTERISTICS

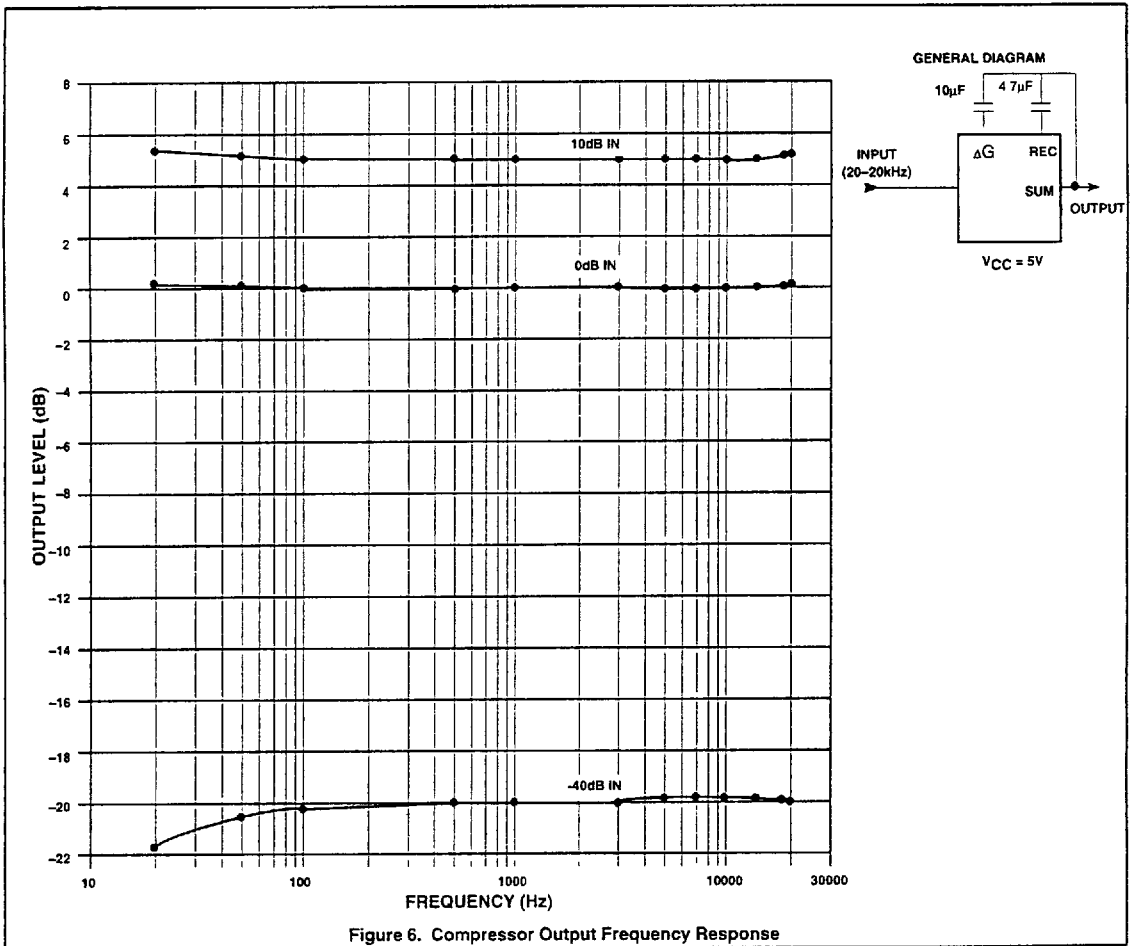

Figure 6. Compressor Output Frequency Response



Low voltage Comparator

NE/SA575

TYPICAL PERFORMANCE CHARACTERISTICS (continued)

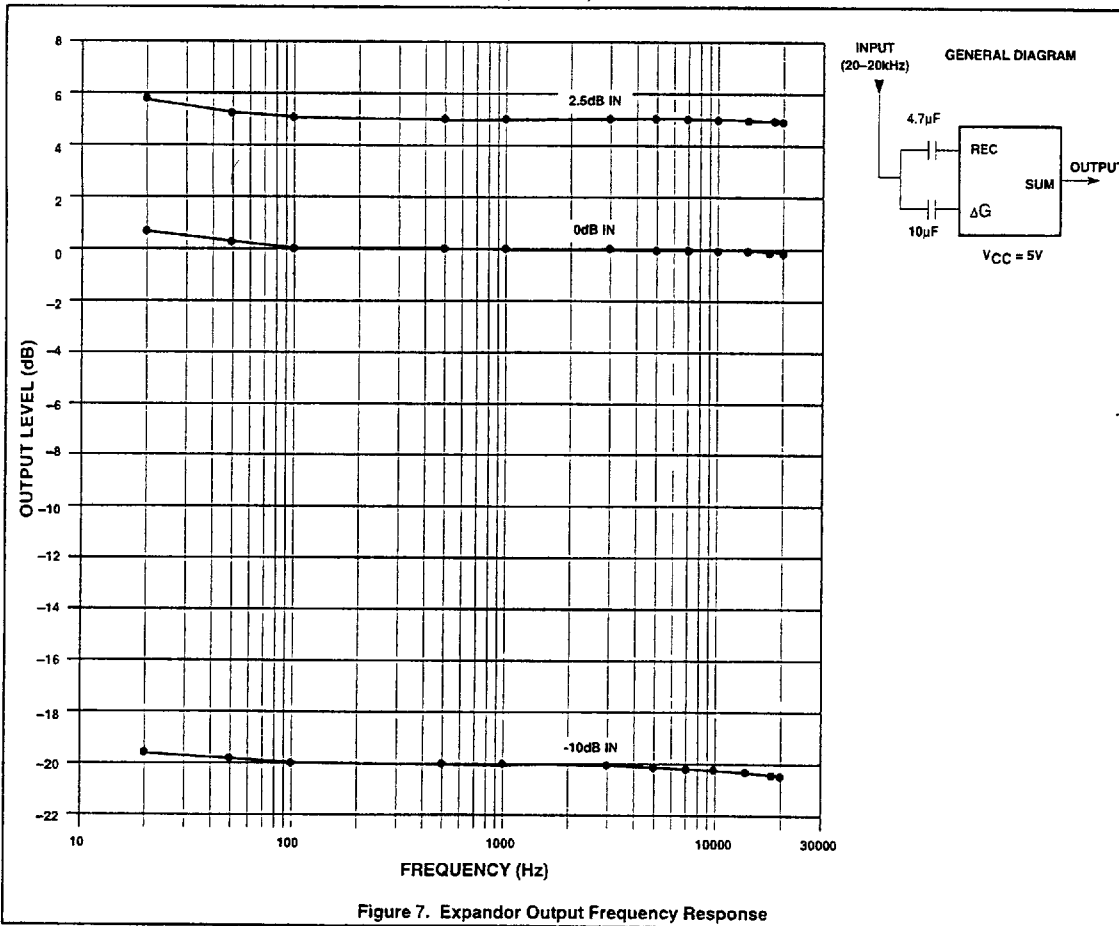

Figure 7. Expander Output Frequency Response

# Low voltage Comparator

NE/SA575

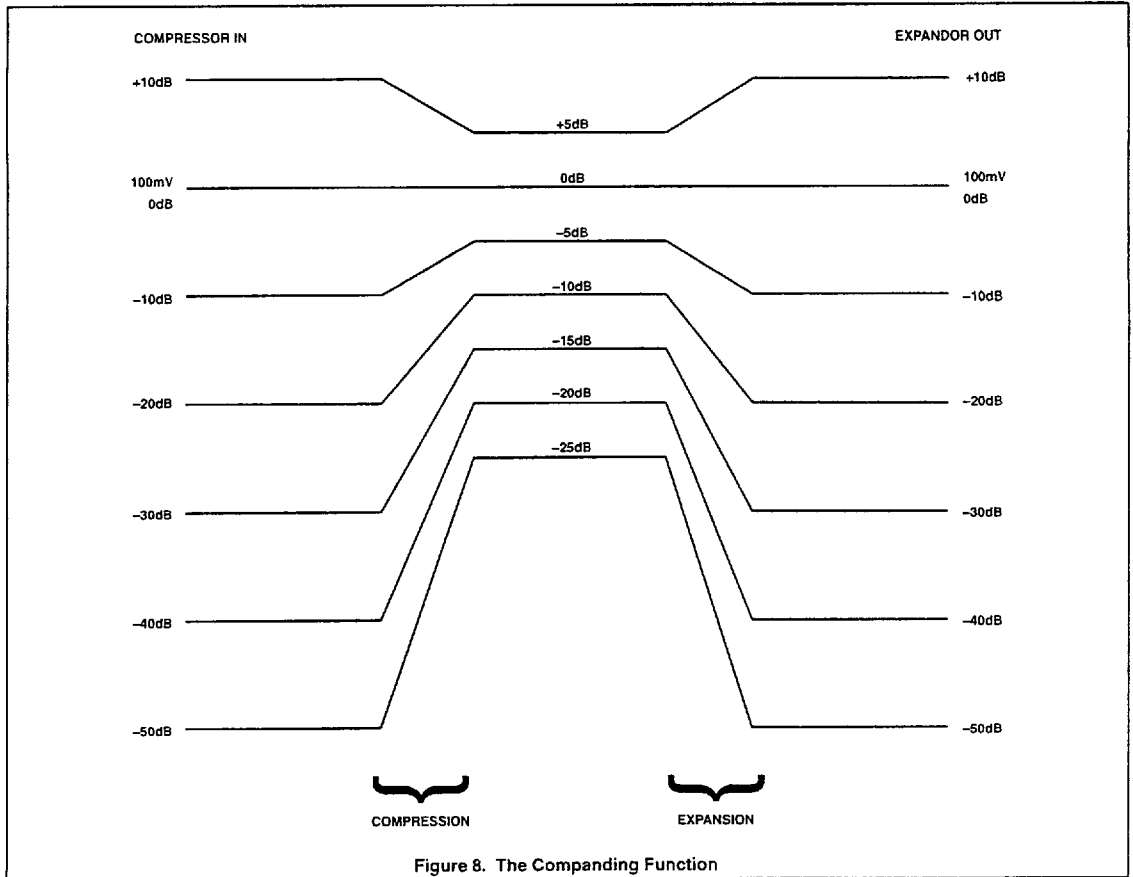

Figure 8. The Compressing Function

This datasheet has been downloaded from:

[www.DatasheetCatalog.com](http://www.DatasheetCatalog.com)

Datasheets for electronic components.